

Video Door Phone Indoor Monitor

----- User Manual

KW-120

KW-120C

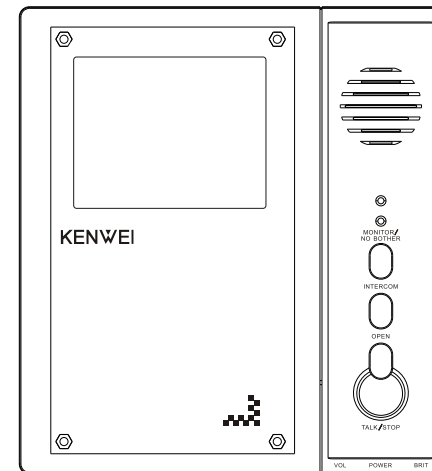

目录

PRODUCT INTRODUCTION.....	2
FEATURES AND PARTS.....	3
SPECIFICATIONS AND ACCESSORIES.....	4
OPERATION GUIDE.....	5
POWER ON/OFF	5
CALL REMIND.....	5
MONITOR / EXIT MONITOR.....	5
TALK / STOP.....	5
OPEN THE DOOR.....	6
NO BOTHER (MUTE) FUNCTION.....	6
EXIT NO BOTHER (MUTE) SETUP.....	6
CALLING BETWEEN INDOOR UNITS (with an extension unit KW-111).....	6
INTERCOM.....	6
OUTDOOR UNIT CALL TRANSFER (with KW-111 extension).....	7
RING VOLUME ADJUSTMENT.....	7
BIRGHTNESS ADJUSTMENT.....	7
INDICATION OF NOT PLACING WELL OF EXTENSION'S HANDLE (with KW-111 extension)	7
WIRLING DIAGRAMS.....	8
INSTALLATION.....	9
KW-120 INSTALLATION.....	9
CONNECTION DIAGRAM.....	9
INSTALLATION ATTENTION	11
TROUBLE SHOOTING GUIDE.....	12
SPECIFICATIONS.....	13

PRODUCT INTRODUCTION

Thank you for purchasing our products of building intercom system series. Please read the instructions carefully and follow the directions before install the products.

Any problem regarding to the product, please query your supplier.

GENERAL FEATURES:

- Hands-free
- No Bother Function
- Brightness Adjustment
- Ring Volume Adjustment (2 grade)
- “Ding Dong” ring and Clear Talking Tone
- Monitor and Remote Unlock
- Connect with Extension Unit KW-111, Have The Function of Call Transfer and Intercom.
- Power Supply: AC100-240V and DC13.5V/1.5A (Optional)



CAUTION:
Please ask professional person if maintenance needed.



Remind users that important operation and maintenance guides are included in the attached user's manual.

* KENWEI reserves the right to change or modify design, features, functions and specifications without any prior notice for the improvement and promotion of products quality.

FEATURES AND PARTS

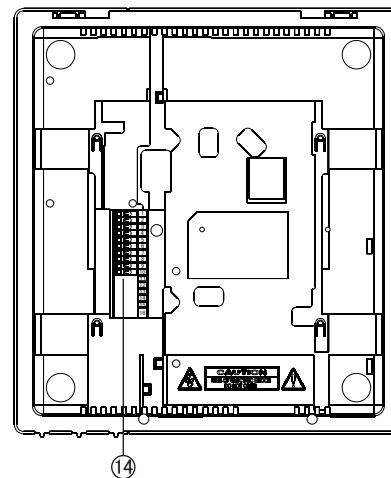
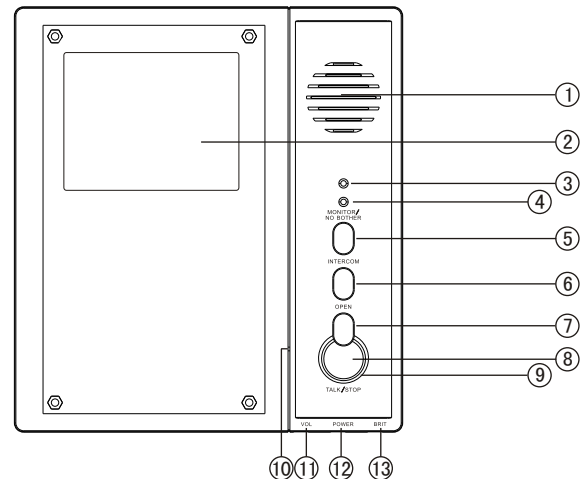

1. Speaker
2. Screen
3. Power Indicator
4. No Bother Indicator
5. Monitor/No Bother
6. Intercom
7. Open
8. Talk/Stop
9. Talking Indicator
10. Microphone
11. Ring Volume Adjustment
12. Power Switch
13. Brightness Adjustment
14. Connection Terminal

* Remark: the function after "/" means the button with different functions under different status.

SPECIFICATIONS AND ACCESSORIES

Product dimension:

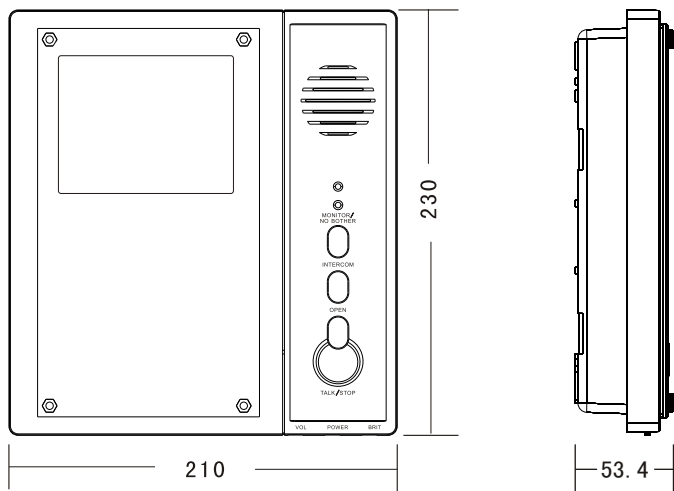

Accessories:

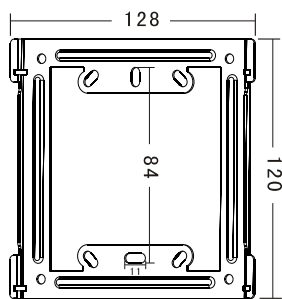

Mounting Bracket



Mounting Screws: $\varnothing 4 \times 25$ mm



Dilatant plug

(Unit: mm)

OPERATION GUIDE

1. Power On/Off

a. Power on

When on the monitor, dial the power switch to the right, then the monitor will enter into standby mode, the power indicator will light on at the same time.

b. Turn off

Dial the power switch to the left, power off, then monitor under OFF mode, and the power indicator will turn off at the same time.

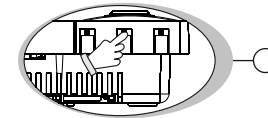

2. Call remind

a. Outdoor camera call indoor monitor

When outdoor camera call indoor monitor, the indoor monitor will display images from outdoor camera automatically, meanwhile, “Ding Dong” ring will sound. If monitor is under No Bother status, it will not sound the ring tone.

b. Indoor monitor call extension unit (KW-111)

When main indoor monitor calling extension unit, the monitor will sound the interval chord ring.

3. Monitor/Exit

When the monitor is under standby mode, press the “monitor” button to monitor the image from outdoor camera. Press the “monitor” button again, and it will exit the monitor function and back to stand-by status. The monitor function will last for 90s and will be off automatically after this period.

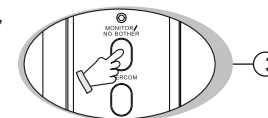

4. Talk/Stop

a. Call to Talk

When the monitor being called, it will sound “Ding Dong”. Press “Talk” button to talk with the visitor at door.

b. Monitor to Talk

When the indoor unit is under monitor status, press “Talk” button and then you can directly talk with the outdoor camera. (Refer to Point 3 “Monitor/Exit”)

c. Stop

When monitor is under talking status, press “Stop” button to stop talking and back to stand-by status, or it will stop automatically after 90s.

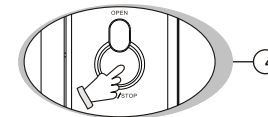

5. Open the door

When monitor is under calling, monitor or talk status, press the “Open” button to open the door. (the door opening time is subject to the time of pressing “Open” button, moreover, the outdoor camera should be equipped with an electronic lock)

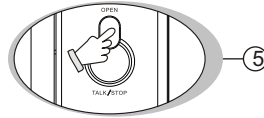

6. No bother (mute) function

When the monitor is under standby mode, press “No Bother” button for 1~2s until the no bother indicator light on, then the monitor enter into no bother status. you can only see the picture of visitor without hearing the ring when there is a calling. Press the “Talk” button to talk with outside.



7. Exit no bother (mute) function

When the monitor is under standby mode, press the “No Bother” button for 1~2s until the no bother indicator turn off, and the unit will exit no bother setup.

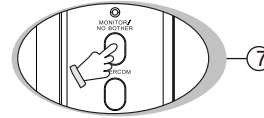

8. Calling between indoor units (with an extension unit KW-111)

a. Main unit (KW-120) calling extension unit KW-111

When KW-111 is under standby mode, press the “Talk” button, the talking indicator will light on. Then press the “Intercom” button, the main unit and extension unit will sound interval chord ring, you can get into intercom by picking up the handset of extension unit KW-111
Remark: if the talking indicator light on, you should press the “Intercom” button within 10s, otherwise the unit will back to standby mode automatically, meanwhile, the talking indicator turn off. You should start the operation once again.

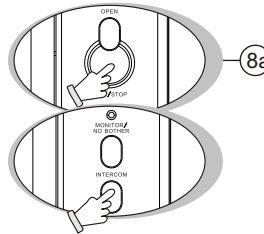

b. Extension unit KW-111 call main unit KW-120

When main unit is under standby mode or No Bother mode, pick up the handset of extension unit and press the “Intercom” button, the main unit will sound interval chord ring. Now you can get into intercom by pressing the “Talk” button of main unit.

Remark: If there is no chord ring, maybe the main unit is under any operation mode or No Bother status.

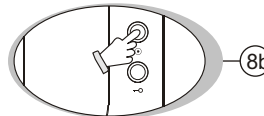

9. Intercom (with an extension unit KW-111)

During calling between indoor units, you can get into the intercom between indoor units by picking up the handset of the be-called indoor unit or pressing its “Talk” button. When you pick up the handset of extension unit, the main unit can talk with it just press the “Talk” button of main unit.

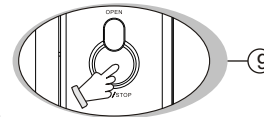

10. Outdoor unit call transfer (with an extension unit KW-111)

a. Main unit (KW-120) call extension unit (KW-111)

When main unit is talking with outdoor camera, press its “INTERCOM” button, the main unit, extension unit and outdoor camera will all sound interval chord ring. Now if the extension unit pick up the handset, he can talk with outdoor camera, the chord ring will stop. In the meanwhile, the talk between main unit and outdoor before will stop, also its talk indicator will turn off.

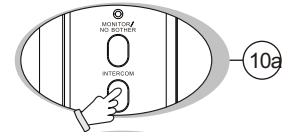

b. extension unit (KW-111) call mail unit (KW-120)

When extension unit is talk with outdoor camera, press its “INTERCOM” button, the main unit, extension unit and outdoor camera will all sound interval chord ring. Now if the main unit press its “TALK” button, he can talk with outdoor camera, the chord ring will stop, talk indicator light on. You just hang up the extension unit's handset.

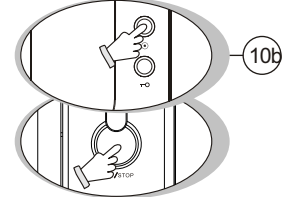

11. Ring volume adjustment

The ring volume can be adjusted by switching the volume switch in any condition.

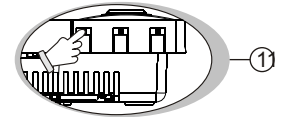

12. Brightness adjustment

The brightness of screen can be adjusted by switching the brightness switch.

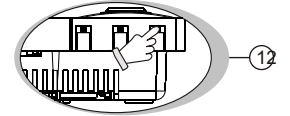

13. Indication of not placing well of extension unit's handset (With Extension Unit KW-111)

When the extension unit is under standby mode, and its handset isn't placed well, the no bother indicator will flash after 10s. You just have to place it in a proper way.

WIRING DIAGRAM

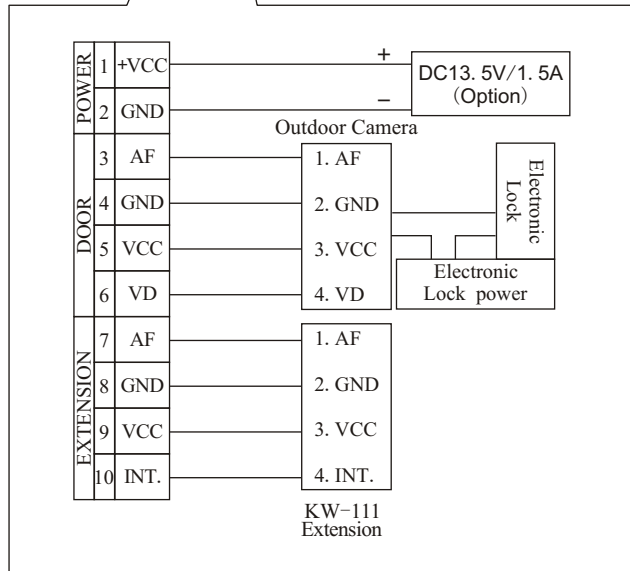
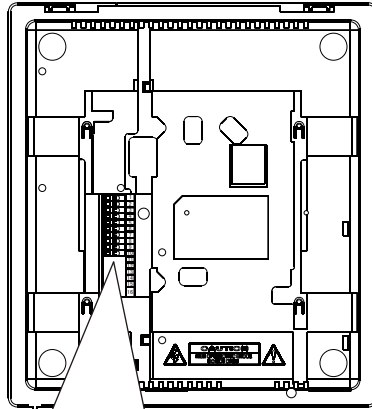

INSTALLATION

KW-120 INSTALLATION

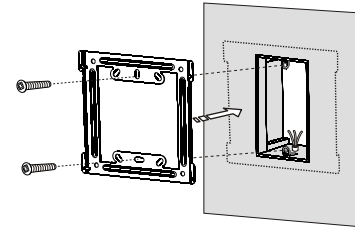

Installation with embedded box

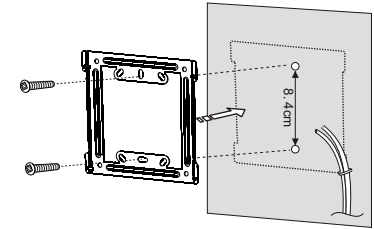

Installation without embedded box

①

1. Fix the bracket to the embedded box which the embedded box have been installed in the wall. If without embedded box, at the selected mounting location, drill 2 holes, the distance from top to bottom is 8.4cm, then push in the dilatant plug, and use the mounting screws to fix the bracket.

Connection Diagram:

Wire peeling length:

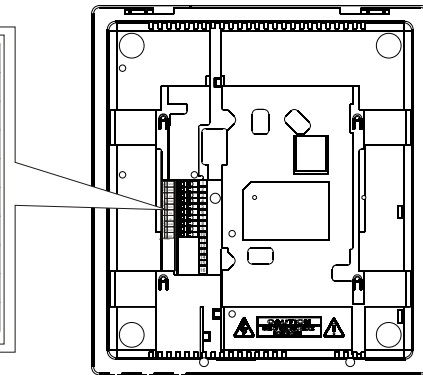
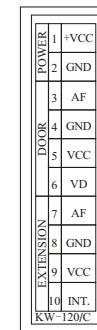
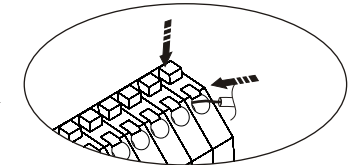
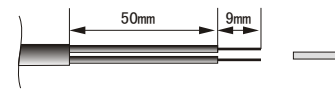

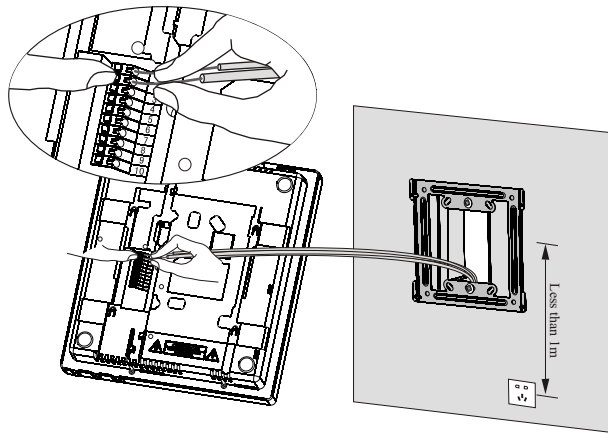

②

2.As the wiring diagram shows, firstly peel the wire, the peeling length should be as per the picture. then connect the wire into the connection terminals, check if they are fixed well.
(Remark: the installation of without embedded box is the same as with embedded box) .

Attention: Installation with embedded box: Tidy up the redundant line and place in the embedded box. Installation without embedded box: Tidy up the line and place it at the back cover's slot.

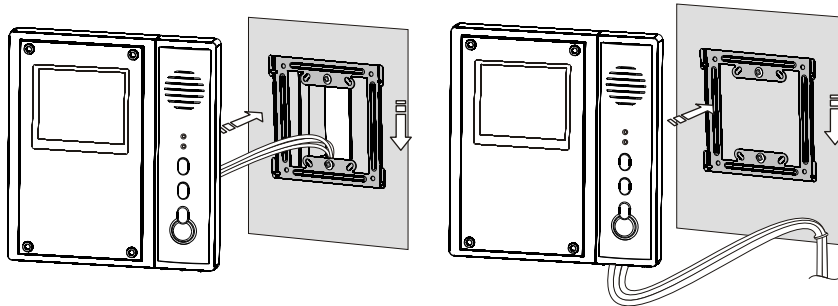

Installation with
embedded box

③

Installation without
embedded box

3. Push the wired monitor unit to the wall mounting bracket hooks and slide it down.
(If the installation is without embedded box, the wires should be pulled out from the top or bottom of back cover)

INSTALLATION ATTENTION

1.Do not expose the unit to sunshine or rain:

Even if you do not use it,don't expose it to sunshine or rain.

2.Do not expose to intense light:

Spotlight may cause stain or striation in the screen.

3.Do not disassemble the unit by yourself:

Improper disassembly may damage the unit or cause electric shock.

4.Do not splash water on the unit:

Install the unit in dry place.In case that the unit gets wet,turn off the unit and contact your dealer.

5.Check the ambient temperature and humidity

Avoid using the unit where the temperature is hotter or colder than specified, otherwise the internal parts may get affected.Special care is required to use the unit at high temperature and humidity.

6.In case of trouble:

If any trouble occurs while you are using the unit,turn off the power and contact your dealer to avoid worse problem or unpredictable accident.

7.About operation:

Keep the unit away from magnetic equipments such as microwave oven or big speaker.If the unit will not be used for a long time,please switch it off.

8.About clean:

Use soft cloth to clean the unit.Do not use any impregnant,such as alcohol, benzene.If you have any problem, please contact your dealer.

9. The equipment shall be installed near the socket outlet and shall be easily accessible.

* Remark:

When you choose the place to install the unit,please pay attention to:
Keep sufficient space for ventilation and easy communication.
Keep sufficient space to adjust while installing.
Not put hot resource under the unit.

TROUBLE SHOOTING GUIDE

Trouble	Possible Cause	Solution
The unit doesn't work at all, the power indicator is off.	The power is OFF, or you do not switch on the power.	Connect the power, or turn on the power refer to OPERATION Point 1.
Camera cannot call indoor unit or the indoor unit cannot monitor camera.	The connection between indoor and outdoor is wrong, or open circuit.	Connect the wire as the diagram show.
Extension (KW-111) and main unit (KW-120) cannot call each other.	The connection between extension and main unit is wrong, or open circuit.	Connect the wire as the diagram show.
No sound during calling.	The main unit KW-120 has set the no bother mode.	Exit the no bother mode.

SPECIFICATIONS

Item \ Model	KW-120		KW-120C	
Display	4" B&W CRT		4" Color TFT	
Power	AC100V-240V ~ 50/60Hz, or DC13.5V/1.5A			
Wiring	4 wires in polarity			
Ring	Ding Dong			
Communication	Hands free			
Max. wiring length	30M	50M	100M	
Wire	RVV4*0.3	RVV4*0.5	RVV4*0.8	
Working Temperature	0°C - 40°C			
Outdoor Camera	Connectable with any 4 wire outdoor camera from our company.			